

# Technaxx® \* operating instructions Technaxx 300W/600W Powerstation TX-201/TX-202

Before using the appliance for the first time, please read the instructions for use and safety information carefully.

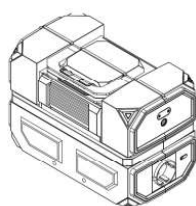

Explorer



Car Charger Cable



AC & AC charger cable(2 Parts)



Y Parallel Cable



User Manual

Service phone No. for technical support: 01805 012643\* (14 cent/minute from German fixed-line and 42 cent/minute from mobile networks).

Free Email: [support@technaxx.de](mailto:support@technaxx.de)

\*The support hotline is available Mon-Fri from 9 am to 1 pm & 2 pm to 5 pm.

Keep this user manual for future reference or product sharing carefully. Do the same with the original accessories for this product. In case of warranty, please contact the dealer or the store where you bought this product.



***Enjoy your product \* Share your experience and opinion on one of the well-known internet portals.***

## Table of contents

Explanation of Warning Symbols and Notes .....	2
Danger! .....	2
Hints .....	3
Safety Instructions .....	4

<b>Features</b> .....	4
<b>Product overview TX-201 300W</b> .....	5
<b>Product overview TX-202 600W</b> .....	6
<b>Display</b> .....	7
<b>How to charge the device</b> .....	9
<b>By Car Adapter</b> .....	9
<b>By Solar panel</b> .....	9
<b>By battery reactivation port</b> .....	10
<b>Example of usage</b> .....	11
The table above should give you an indication, depending on your devices, capacity of the batteries you may get different results with your products. Mini refrigerator may not start if they are driven by compressor, due to high current during starting process. ....	
<b>Cleaning and maintenance</b> .....	12
Declaration of conformity .....	12
Disposal .....	12

## Explanation of Warning Symbols and Notes

	<p>Risk of electric shock</p> <p>This symbol indicates product parts energized with a dangerous voltage of sufficient magnitude to constitute a risk of electric shock.</p>
	<p>Warning</p> <p>This symbol is used to indicate safety instructions or to draw your attention to specific hazards and risks.</p>
	<p>This symbol is used to indicate additional information or important notes.</p>

## Danger!

When using the equipment, a few safety precautions must be observed to avoid injuries and damage. Please read the complete operating instructions and safety regulations with due care. Keep this manual in a safe place, so that the information is available at all times. If you give the

equipment to any other person, hand over these operating instructions and safety regulations as well. We cannot accept any liability for damage or accidents which arise due to a failure to follow these instructions and the safety instructions. Do not use this product near heat sources such as fires or stoves.

Avoid contact with any liquid. Do not immerse the product in water or get it wet. Do not use this product in rain or wet conditions. Do not use this product in environments with strong static electricity/magnetic fields.

Do not disassemble the product in any way or pierce the product with sharp objects. Do not insert any metal objects inside this product, as this creates a risk of electric shock and can cause irreparable damage to the product. Do not use any unofficial components or accessories. For replacement of any parts or accessories, please contact your dealer for advice. When using the product, please strictly abide by the ambient temperature specified in this user manual. If the temperature is too high, it may cause a fire or explosion; if the temperature is too low, the performance of the product may be severely degraded, or the product may stop working. Do not place any heavy objects on top of the product.

During use, do not forcibly block the fan operation or place the product in a non-ventilated or dusty place. Please avoid shock, drop or severe vibration when using the product. In case of severe external shock, immediately turn off the power and stop using the product. Make sure the product is securely fastened during transportation to avoid vibration and shock. If the product is accidentally dropped into water during use, please place it in a safe and open place and keep it away from it until it is completely dry. Dried product should not be reused and should be disposed of properly in accordance with Disposal Guidelines below. If the product catches fire, we recommend that you use the fire extinguisher in the following order: water or mist, sand, fire blanket, dry chemical, and finally a carbon dioxide fire extinguisher. Use a dry cloth to remove dirt from the product ports. Place the product on a flat surface to prevent damage from tipping over the product. If the product is overturned and seriously damaged, turn it off immediately, place the battery in an open place, away from flammable objects and people, and dispose of it in accordance with local laws and regulations. Make sure to keep the product out of the reach of children and pets.

## Hints

- The device is intended exclusively for private and not for commercial use.
- Only use this device as described in this user manual.
- Do not place any part of this device in water or any other liquid.
- Do not handle

the device with wet hands. ● When disconnecting the cable, always pull at the plug. Do not pull on the cable itself. ● Do not let the cord on the edge of a table or work surface. ● Prevent it comes into contact with hot surfaces. ● Keep it away from heat sources to avoid deformation of plastic parts.

## Safety Instructions

- Children are not allowed to play or use the equipment. ●Unless supervised, children are not allowed to clean the equipment and carry out user-level maintenance work. ●Any errors made in following the safety regulations and instructions may result in an electric shock, fire and/or serious injury. ●The equipment and packaging material are not toys. ●Do not let children play with plastic bags, foils or small parts. ●There is a danger of swallowing or suffocating! ● The device is intended only for private use. ● Only operate the product indoors or under dry condition ● Keep children and bystanders away from your work area. ●Do not use the unit in a damp or wet environment. ● Ensure that there is sufficient lighting. ●Do not expose the unit to direct sunlight, rain or snow. ●Do not use the charger near explosive gases or liquids. ●Keep the item in a dry, safe place out of the reach of children. ●Do not carry the item by the cable and do not pull on the cable to pull the plug out of the socket. ● the plug from the socket. Protect the cable from heat, oil and sharp edges. ●Before use, make sure that the unit and all cables are in perfect condition. ● If the cable is damaged, have it replaced by an authorised specialist workshop. ● Do not attempt to carry out any repairs yourself. ● Always disconnect the item from the mains when not in use. ●Keep all the ventilation slots clean.

## Features

	<b>TX-201</b>	<b>TX-202</b>
<b>Output</b>	<b>300W/ 230V,50Hz pure sine wave</b>	<b>600W/ 230V,50Hz pure sine wave</b>
<b>Socket</b>	<b>1 x Schuko</b>	<b>2 x Schuko</b>
<b>USB</b>		
<b>USB-A</b>	<b>2 x 5V 3.1A max. 15W shared</b>	
<b>USB-A</b>		<b>2 x USB-A (QC 3.0), DC5V,3A, DC9V,2A, DC12V,1.5A, max 18W (shared)</b>
<b>USB-C</b>	<b>1 x 60W max, (5-20V 3A max.)</b>	

		1 x PD (DC 5V 3A, 9V 3A, 12V 3A, 15V 3A, 20V 5A) (Max 100W)
Cigarette port	1 x 12V 10A (120W max.)	1 x 12V 10A 2 x 12V 10A (120W max. shared)
LED Light	3 different function 2W	
Input		
Hollow Socket 1 X 7909	DC 11-30V, 5A (100W max)	DC 11-30V, 6A (150W max)
XT60	non	DC 11-30V (max.150W)
USB-C	1 x Battery activation port max. 5V, 2A max.	
Battery	Li Ion	
Capacity	12,5AH/ 315Wh	20Ah, 504Wh
Voltage	25,2V	
Safety function	Overload-, Over Voltage- Over Current-, Short Circuit-, and Low Voltage- Protection	
Display	Remaining Power, Input Power, output Power, remaining run time, remaining charging time, Inverter Rated Power, Temperature Status, Fan icon, Warning	
Dimensions	27 x 15 x 18.2 cm	28.7 x 20.5 x 19.8 cm
Weight	3.9kg	6.25kg

## Product overview TX-201 300W

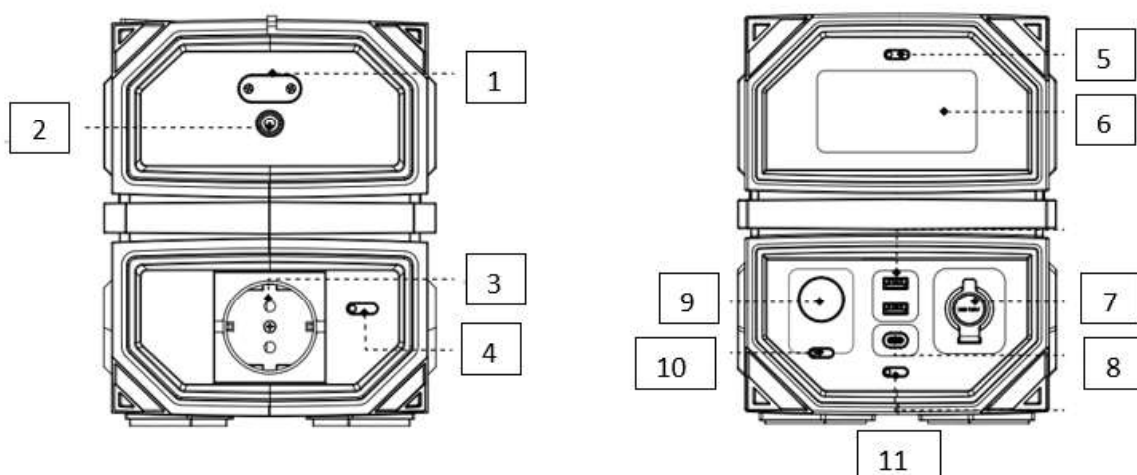

1	Battery reactivation port	6	Display
2	DC Input	7	Cigarette lighter port

<b>3</b>	Schuko Socket	<b>8</b>	USB ports
<b>4</b>	AC switch	<b>9</b>	LED Light
<b>5</b>	Display switch	<b>10</b>	LED switch
<b>11</b>	DC switch		

## Product overview TX-202 600W

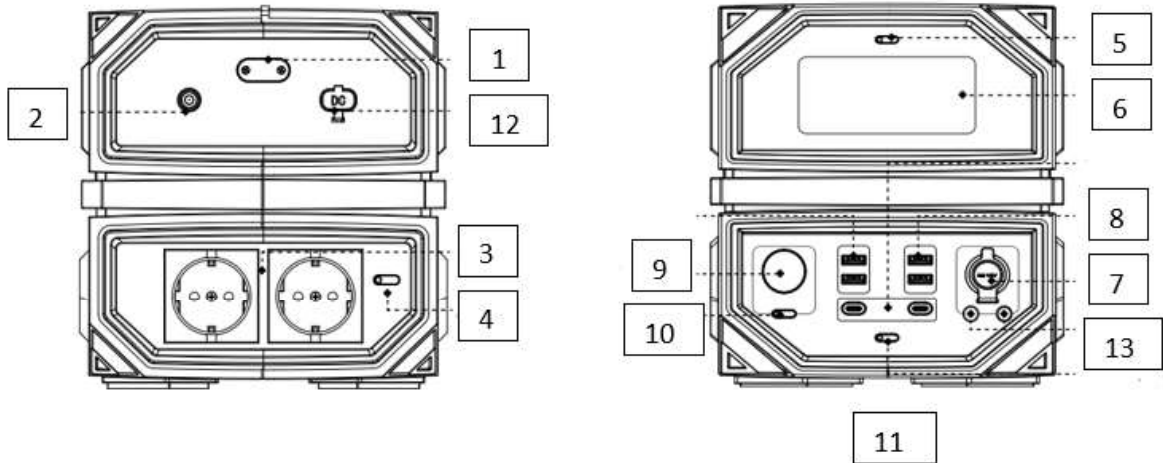

<b>1</b>	Battery reactivation port	<b>6</b>	Display
<b>2</b>	DC Input	<b>7</b>	Cigarette lighter port
<b>3</b>	Schuko Socket	<b>8</b>	USB ports
<b>4</b>	AC switch	<b>9</b>	LED Light
<b>5</b>	Display switch	<b>10</b>	LED switch
<b>11</b>	DC switch	<b>12</b>	XT 60 Solar input
<b>13</b>	2 x DC Out 12V 10A max. 120W shared		

# Display

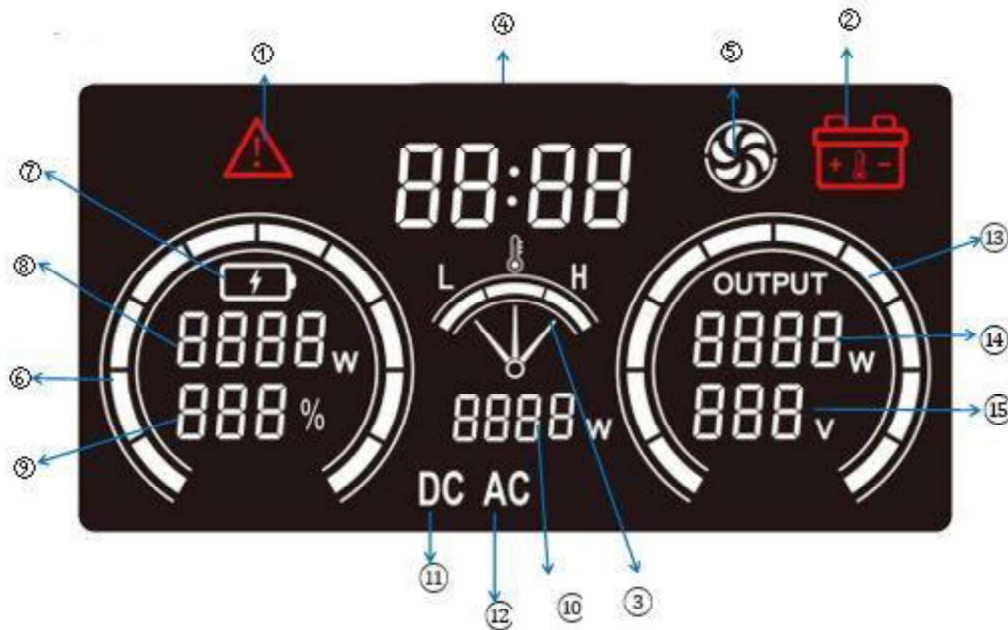







Figure Number	Figure	Fault Description and Handling Methods		
1		Inverter fault icon, displayed when fault occurs (Including: short circuit, overload, under voltage, over voltage, over temperature, etc.) When the voltage is undervoltage, there will be a "di...di..." alarm sound (10 seconds), and the AC icon on the LCD screen will flash, and the green light on the AC switch button will flash.		
2		Battery failure icon		
3		 Normal temperature Figure 3 The pointer points to the middle	 Low temperature fault, icon 1 and 3 appear at the same time Figure 3 The pointer points to L	 High temperature fault, icon 1 and 3 appear at the same time Figure 3 The pointer points to H
		In low temperature environment, battery discharge failure: When $-20\pm 3^{\circ}\text{C}$ , the battery is protected at low temperature level I, and the icons 1, 2, and 3 are displayed at the same time, $-25\pm 3^{\circ}\text{C}$ , battery level II low temperature protection, LCD breath-holding screen, no display, and red light flashing on AC switch button, Recovery temperature after discharge low temperature protection: $-10\pm 3$		

		<p>°C.</p> <p>In low temperature environment, battery charging failure: When <math>-10\pm 3^{\circ}\text{C}</math>, the battery is under low temperature protection, the icons 1, 2, and 3 are displayed at the same time, and the icon 3 is flashing, Recovery temperature after charging low temperature protection: <math>0\pm 3^{\circ}\text{C}</math>.</p> <p>High temperature environment, battery discharge failure: When the temperature is <math>60\pm 3^{\circ}\text{C}</math>, the battery is protected against high temperature level I, and the icons 1, 2, and 3 are displayed at the same time, When the temperature is <math>65\pm 3^{\circ}\text{C}</math>, the battery is protected against high temperature level II, and the LCD screen will hold the breath without any display. At the same time, the red light on the AC switch button flashes, Recovery temperature after discharge high temperature protection: <math>55\pm 3^{\circ}\text{C}</math>.</p> <p>Battery charging failure in high temperature environment: When the temperature is <math>60\pm 3^{\circ}\text{C}</math>, the battery is protected against high temperature, the icons 1, 2, and 3 are displayed at the same time, and the icon 3 is flashing, Recovery temperature after charging high temperature protection: <math>50\pm 3^{\circ}\text{C}</math>.</p>
		
4		<p>Time required to fully charge the battery</p> <p>Battery life time</p>
5		Fan icon (appears when the fan is working)
6~9		<p>Figure 6: Battery level display (about 10% per grid); When charging, the bar corresponding to the battery will flash; if the battery shows 0%, the Figure 6 will flash.</p> <p>Figure 7: Battery charging icon (appears while charging)</p> <p>Figure 8: Battery charging power (appears while charging)</p> <p>Figure 9: Battery Percentage</p>
10~12		<p>Figure 10: Energy Storage Power Specifications (Inverter Power)</p> <p>Figure 11: Appears when the DC switch is open, flashes when overloaded or short-circuited,</p> <p>Figure 12: Appears when the AC switch is turned on, and flashes when there is a fault (Including: short circuit, overload, under voltage, over voltage, over temperature, etc.)</p>
13~15		<p>Figure 13: Display of total load power (about 10% per grid)</p> <p>Figure 14: Total load power (sum of all loads, including: AC, USB-A, TYPE-C, DC, LED lights)</p> <p>Figure 15: AC output voltage</p>

When the unit is charged and under load at the same time, it may happen that the display shows unreasonable values on input and output Display, e.g. if the unit get charged with a power of 100W and



discharged with a power of 50W, the display shows less than 50W charging power. This happens because of a priority connection of the input power circuit, this input power gets directly used to operate the item on the 230V output port.

If the output power is bigger than the input power you may see that the Display shows a smaller number of consumed power, e.g. charge with 100W, discharged power is 200W, the display shows ~100W on the output Display.

**How to charge the device**

The battery power of the energy storage power supply will be consumed during use. You can choose the following methods to charge the energy storage power supply : Note: All models do not support multiple charging methods at the same time, only one of them can be selected for charging.

**By AC-Adapter**

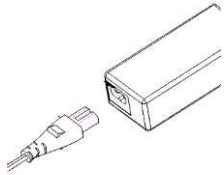
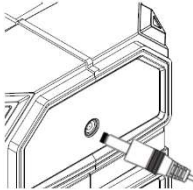
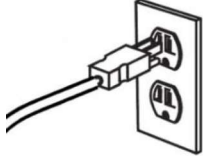
		
<p>Connect the AC plug cord to the adapter</p>	<p>Insert the adapter DC output plug into the device charging port</p>	<p>Insert the adapter AC plug into the mains outlet</p>

**By Car Adapter**

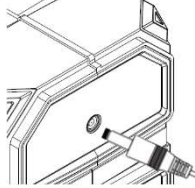
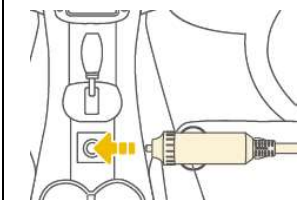
 <p>Insert the DC output plug into the device charging port</p>	 <p>Insert the car cigarette lighter plug into the car cigarette lighter</p>
--	--

**By Solar panel**

Make sure the solar panel output is in the range of the allowed input parameter (see table above) we suggest to use the 100W Solar Panel TX-206 foldable Solar Panel or TX-208

flexible Solar Panel. Both panels are equipped with different connector's fitting the Powestation TX-201 and TX-202.

**By battery reactivation port.**

The battery reactivation port (1) is for rescue charging only, use this charging method if other way of charging is not possible only! Remove the protective cover with a screwdriver, plug the Type-C charging cable (not included) into the charging port, and plug the charger (not included) into the mains socket. It takes a long time to charge here (about 10-14 hours) until the LCD screen lights up.

**Use of Product**

The Products have different function units inside, each is equipped with a switch to switch the relevant function on or off

**Display:**

To activate the Display, hold the switch for ~1 second, the Display lights up and show the relevant status-information for further details go to the point Display. It will automatically turn off if there is no operation for 5 minutes; you can press any button to wake up.

**DC unit:**

To activate the DC ports (USB and 12V), hold the DC power switch for ~1 second, the switch will light up and show the DC unit is ready to use.

**AC Unit.**

To activate the AC ports, hold the AC power switch for ~1 second, the switch will light up and show the AC unit is ready to use. We suggest to switch the AC ports off as long as they are not used, the internal inverter need battery power as well as no item is connected.

**LED:**

To activate the LED hold the LED switch for ~1 second, the LED will light up, press the switch again to change the different functions.

**Troubleshooting**

Fault Category	Fault Description and Handling Methods
Battery High Temperature Protection	Put the device in a cool and ventilated place, and it can be restored after the temperature is lowered. Notice: Do not directly cool the equipment by freezing, so as not to damage the equipment!!!
Battery Low Temperature Protection	Put the device in a warm environment, and it can be restored after the temperature rises.

	Notice: Do not put the device into the oven, or directly heat the device by other means to avoid danger!!!
DC does not charge (Car / Solar / Adapter)	Please check if the charging voltage meets the device requirements: (Car/Solar charging) DC charging voltage requirements 11-30VDC
	Please check if the indicator light on the power adapter is on, if not, please check: Is the adapter connected, Whether the AC socket is normal, and whether the AC mains is normal; (Note: The inspection requires professionals and professional equipment to avoid electric shock)
	Battery high temperature or low temperature protection, please refer to the corresponding method.
No AC output	Check that the AC switch is on. (On: the green indicator light on the button is on, off: the indicator light is off)
	Check whether the load device is connected to the AC output
	The equipment is overloaded or short-circuit protected. After reducing the load or eliminating the fault, it can be restored after restarting.
	Battery under-voltage protection, need to be charged before use; AC switch should be turned off and then turned on.
Cigarette lighter, DC Ports, USB, TYPE-C no output	Whether the DC switch is on. (On: the green indicator light on the button is on, off: the indicator light is off)
	Check whether the green indicator on the switch button is flashing. If it flashes, it may be caused by overload or short circuit or over temperature of the DC module. After checking and troubleshooting, it can return to normal. Overload recovery: reduce the load to within the rated range, Short-circuit recovery: check the load equipment and eliminate the short-circuit fault, Module over-temperature recovery: suspend use and resume after cooling.
	Battery under-voltage protection, need to be charged before use
	Battery high temperature or low temperature protection, please refer to the corresponding method
LED light does not light up	Whether the LED switch is on. (On: the green indicator light on the button is on, off: the indicator light is off)
	Battery under-voltage protection, need to be charged before use
	Battery high temperature or low temperature protection, please refer to the corresponding method
LCD not responding	Battery high temperature or low temperature protection, please refer to the corresponding method
	If the battery is seriously short of power, charge it through the battery rescue port until the LCD screen is lit, and then fully charge it in the usual way

## Example of usage

	TX-201 300W	TX-202 600W
Min. loading time	45 min.	
Load ... up to		

Mobile phone	23 x	37 x
Tablet	11 x	18 x
Drone	21 x	34 x
Camera	18 x	29 x
Notebook	5 x	8 x
Run mini Refrigerator	4h	6h

The table above should give you an indication, depending on your devices, capacity of the batteries you may get different results with your products. Mini refrigerator may not start if they are driven by compressor, due to high current during starting process.

## Cleaning and maintenance

**Danger!** Always pull out the mains power plug before starting any cleaning work. Keep all safety devices, air vents and the housing free of dirt and dust as far as possible. Wipe the equipment with a clean cloth or blow it with compressed air at low pressure. • We recommend that you clean the device immediately each time you have finished using it. • Clean the equipment regularly with a moist cloth and some soft soap. Do not use cleaning agents or solvents; these could attack the plastic parts of the equipment. Ensure that no water can seep into the device. The ingress of water into an electric tool increases the risk of an electric shock. • The charger should be placed in a dry room for storage. Any corrosion must be cleaned off the charging terminals.

## Declaration of conformaty



The EU declaration of conformity can be obtained from the address given [www.technaxx.de/](http://www.technaxx.de/) (in bottom bar "Konformitätserklärung").

## Disposal



Dispose of packaging. Dispose of the packaging according to type. Dispose of cardboard and carton in the waste paper foils to the recyclables collection.

Dispose of old appliance (Applicable in the European Union and other European countries with separate collection (collection of recyclable materials) Old appliances must not be disposed of with household waste! If the product can no longer be used, every consumer is legally obliged to dispose of old appliances separately from household waste, e.g. at a collection point in his or her municipality or district. e.g. at a collection point in his or her



municipality/borough. This ensures that old appliances are recycled properly and that negative impacts on the environment are avoided. This is why electrical appliances are marked with the symbol shown here.

Made in China  
Vertrieben durch:  
Technaxx Deutschland GmbH & Co. KG  
Konrad-Zuse-Ring 16-18,  
61137 Schöneck Germany