

Lifenaxx[®] * User Manual

Lifenaxx Window Cleaning Robot LX-083

Before using the appliance for the first time, please read the instructions for use and safety information carefully.

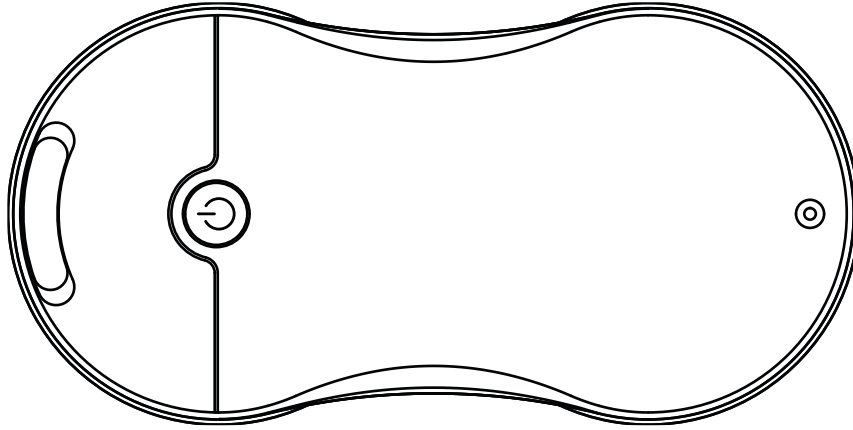

This appliance is not intended for use by persons (including children) with reduced physical, sensory or mental capacities, or by persons lacking in experience or knowledge, unless they are supervised or instructed on the use of this device by a person responsible for their safety. Children should be supervised to ensure they do not play with this device.

Keep this user manual for future reference or product sharing carefully. Do the same with the original accessories for this product. In case of warranty, please contact the dealer or the store where you bought this product.

Enjoy your product. * Share your experience and opinion on one of the well-known internet portals.

Specifications are subject to change without notice - please be sure to use the latest manual available on the manufacturer's website.

Table of Contents

Hints	2	Start Cleaning	12
Important Safety Instructions.....	3	End Cleaning.....	12
Warnings	3	Function of Cleaning	13
Beware of Risk of Electric Shock	4	Wipe with Dry Cleaning Pad	13
Safety rules for rechargeable batteries.....	5	Water Spraying Function....	13
Disclaimer.....	5	Three Intelligent Path Planning Modes	14
Product contents	7	UPS Power Failure System.....	14
Product overview.....	7	LED Indicator Light.....	14
Remote Control	9	Maintenance	14
Before Usage	9	Troubleshooting.....	16
Product Usage.....	10	Technical Specifications.....	17
Power Connection.....	10	Support.....	17
Charging	10	Care and maintenance	17
Install the Cleaning Pad	10	Declaration of Conformity.....	18
Fasten the Safety Rope	11	Disposal.....	18
Inject Water or Cleaning Solution	12		

Hints

● Only use the product for purposes due to its intended function ● Do not damage the product. Following cases may damage the product: Incorrect voltage, accidents (including liquid or moisture), misuse or abuse of the product, faulty or improper installation, mains supply problems including power spikes or lightning damage, infestation by insects, tampering or modification of the product by persons other than authorized service personnel, exposure to abnormally corrosive materials, insertion of foreign objects into the unit, used with accessories not preapproved. ● Refer to and heed all warnings and precautions in the user manual.

Important Safety Instructions

- Do not allow children to operate this product. Users with physical, sensory or psychological disorders, or those who lack knowledge of the functions and operation of this product must be supervised by a fully competent user after being familiar with the use procedures and safety risks. Users must use the product under the supervision of a fully capable user after familiarizing themselves with the use process and safety risks. Children are not allowed to use. This product should not be used by children as a toy.
- This product can only be used to clean framed windows and glass (not suitable for frameless windows and glass). If the glass cement of the glass frame is damaged, in case the product pressure is insufficient and fall down, please pay special attention to this product during cleaning process. User must observe the using scenario to ensure that the product is used safely and securely.

Warnings

Please use the original adapter!

(Using a non-original adapter may cause product failure or cause damage to the product)

- Make sure the adapter has enough space for ventilation and heat dissipation during use. Do not wrap up the power adapter with other objects.
- Do not use the adapter in a humid environment. Do not touch the power adapter with wet hands during use. There is an indication of the voltage used on the adapter nameplate.
- Do not use a damaged power adapter, charging cable or power plug. Before cleaning and maintaining the product, the power plug must be unplugged and do not disconnect the power by disconnecting the extension cable to prevent electric shock.
- Do not disassemble the power adapter. If the power adapter is malfunctioning, please replace the entire power adapter. For

assistance and repairing, contact your local customer service or distributor.

- Please do not disassemble the battery. Do not dispose the battery in a fire. Do not use in a high temperature environment above 60°C. If the battery of this product has not been handled properly, there is a risk of burning or causing chemical damage to the body.

- Please hand over the used batteries to the local professional battery and electronic product recycling center for recycling.

- Please strictly follow this manual to use this product.

- Please keep this manual for future use.

- Do not immerse this product in liquids (such as beer, water, drinks, etc.) or leave it in a humid environment for a long time.

- Please keep it in a cool dry place and avoid direct sunlight. Keep this product away from heat sources (such as radiators, heaters, microwave ovens, gas stoves, etc.).

- Do not place this product in a strong magnetic scene.

- Store this product out of reach of children.

- Use this product in 0°C~40°C ambient temperature.

- Do not clean damaged glass and objects with uneven surface. On uneven surfaces or damaged glass, the product will not be able to generate sufficient vacuum adsorption.

- The built-in battery of this product can only be replaced by the manufacturer or designated dealer / after-sales center to avoid danger.

- Before removing the battery or dispose of the battery, the power must be disconnected.

- Operate this product in strict accordance with the instructions, if any property damage and personal injury caused by improper use, the manufacturer is not responsible for it.

Beware of Risk of Electric Shock

Make sure the power is completely disconnected and the machine is turned off before cleaning or maintaining the body.

- Do not drag the power plug from the socket. The power plug should be unplugged correctly when power-off.

- Do not attempt to repair the product yourself. Product maintenance must be carried out by an authorized after-sales center or dealer.
- Do not continue to use if the machine is damaged/power supply is damaged.
- If the machine is damaged, please contact the local after-sales center or dealer for repair.
- Do not use water to clean the product and power adapter.
- Do not use this product in the following dangerous areas, such as place with flames, bathrooms with running water from the nozzles, swimming pools, etc.
- Do not damage or twist the power cord. Do not put heavy objects on the power cord or adapter to avoid damage.

Safety rules for rechargeable batteries

The product uses rechargeable batteries. But ALL batteries can EXPLODE, CATCH FIRE, and CAUSE BURNS if disassembled, punctured, cut, crushed, short-circuited, incinerated, or exposed to water, fire, or high temperatures, so you must handle them with care.

To use the rechargeable batteries safely, follow these guidelines:







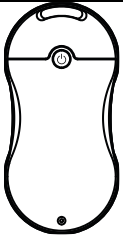
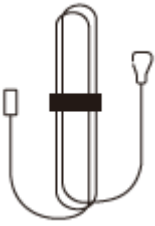

- ALWAYS store spare the item in a cool, dry, ventilated area.
- ALWAYS keep the item away from children.
- ALWAYS follow local waste and recycling laws when throwing used batteries away.
- ALWAYS use the product to charge the rechargeable batteries. ● NEVER disassemble, cut, crush, puncture, short-circuit, dispose of batteries in fire or water, or expose the rechargeable battery to temperatures above 50°C.

Disclaimer

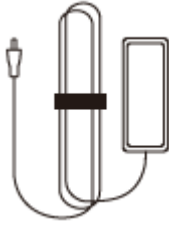
- In no event shall Technaxx Deutschland be liable for any direct, indirect punitive, incidental, special consequential damage, to property or life, improper storage, whatsoever arising out of or

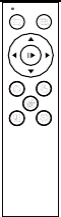
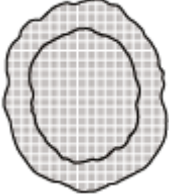
connected with the use or misuse of their products. ● Error messages may appear depending on the environment it is used in.

Product contents





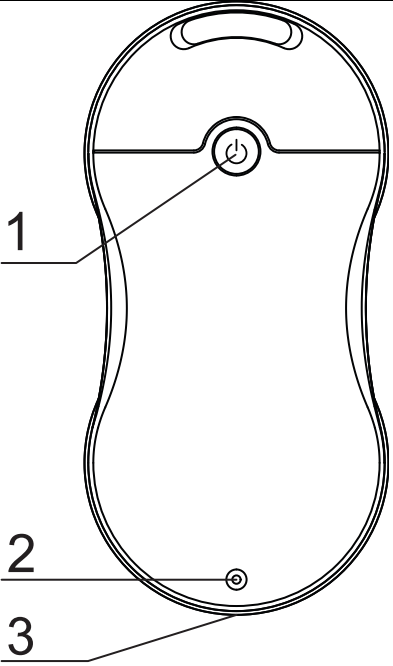
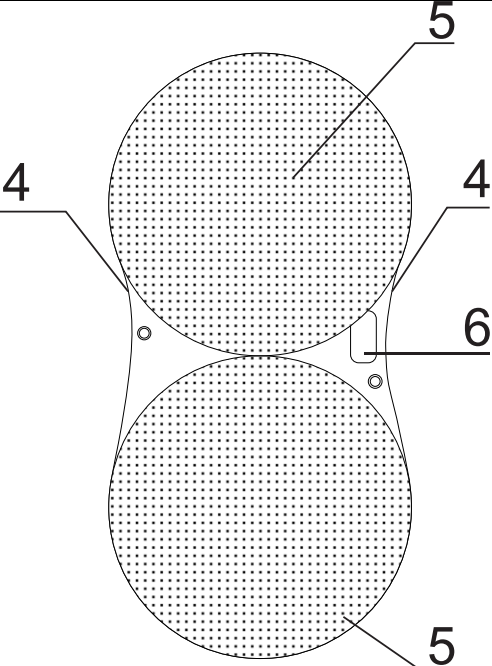







					
Robot LX-083	Safety Rope	AC Cable	Power Adapter	Extension Cable	Remote
					
Cleaning Pad	Water Injection Bottle	Water Spraying Bottle		Manual	

Product overview

Top Side		Bottom Side	
			
1	On/Off Indicator LED	2	Power Cord Connection
3	Safety Rope	4	Water Spray Nozzle
5	Cleaning Pad	6	Remote Control Receiver

Remote Control

- A.** Do not disassemble the battery, do not put the battery in fire, there is a possibility of deflagration.
- B.** Use AAA/LR03 batteries of the same specification as required. Do not use different types of batteries. There is a danger of damaging the circuit.
- C.** New and old batteries or different types of batteries cannot be mixed.

	Optional function button (not valid for this version)		Clean toward upward	
	Manual water spraying		Clean toward the left	
	Automatic water spraying		Clean toward the right	
	Optional function button (not valid for this version)		Clean toward down	
	Start / Stop		Automatic cleaning	
	Spot cleaning		Continue cleaning	

Before Usage

1. Before operation, make sure the safety rope is not broken and tie it securely to a fixed indoor furniture.
2. Before using the product, make sure there the safety rope is not damaged and the knot is secured.
3. When cleaning the glass of the window or door without protective fence, set up a safety warning area downstairs.
4. Fully charge the built-in backup battery before use (blue light is on).
5. Do not use in rainy or humid weather.
6. Turn on the machine first and then attach it to the glass.
7. Make sure the machine is firmly attached to the glass before letting go of your hands.
8. Before turning off the machine, hold the machine to avoid dropping.
9. Do not use this product to clean frameless windows or glass.

10. Make sure the cleaning pad is properly attached to the bottom of the machine to prevent air pressure leakage during adsorption.
11. Do not spray water towards the product or the bottom of the product. Only spray water towards the cleaning pad.
12. Children are not allowed to use the machine.
13. Remove all items from the glass surface before use. Never use the machine to clean broken glass. The surface of some frosted glass may be scratched during cleaning. Use with caution.
14. Keep hair, loose clothing, fingers and other parts of body away from the working product.
15. Do not use in those areas with flammable and explosive solids and gases.

Product Usage

Power Connection

- A.** Connect the AC power cable to the adapter
- B.** Connect the power adapter with the extension cable
- C.** Plug the AC power cord into an outlet

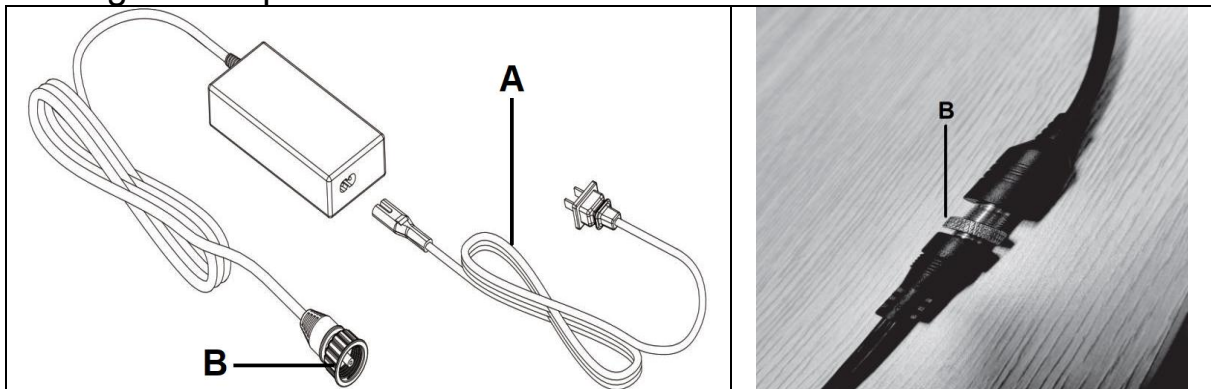

Charging

The robot has built-in backup battery to provide power in the event of power failure. Make sure the battery is fully charged before use (blue light is on).

- A.** First connect the power cable to robot and plug the AC cable into an outlet, blue light is on. It indicates that the robot is in the charging state.
- B.** When the blue light remains on, it means the battery is fully charged.

Install the Cleaning Pad

According to the picture shown, make sure to put the cleaning pad on the cleaning wheel correctly to prevent air-pressure leakage.

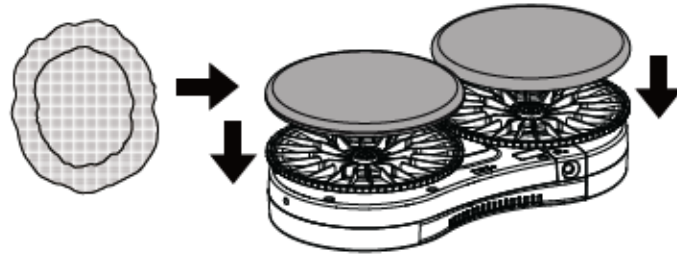

Fasten the Safety Rope

- A.** For the doors and windows without balcony, hazard warnings marks must be placed on the ground downstairs to keep people away from.
- B.** Before use, please check whether the safety rope is damaged and whether the knot is loose.
- C.** Be sure to fasten the safety rope before use, and tie the safety rope on fixed objects in the house to avoid danger.



Inject Water or Cleaning Solution

- A.** Only Fill with water or special cleaning agents diluted with water
- B.** Please do not add any other cleaners to the water tank
- C.** Open the silicone cover and add cleaning solution

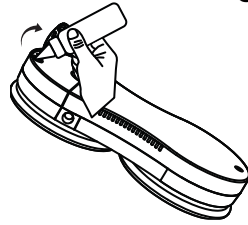

Start Cleaning

- A.** Short press “ON/OFF” button to power on, vacuum motor starts working
- B.** Attach the robot to the glass and keep a certain distance from the window frame
- C.** Before releasing your hands, make sure the robot is attached to the glass firmly

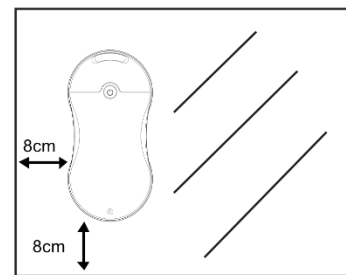
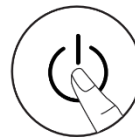

End Cleaning

- A.** Hold the robot with one hand, and press “ON/OFF” button with the other hand for about 2 seconds to turn off the power
- B.** Take down the robot from window.
- C.** Untie the safety rope, place the robot and its related accessories in a dry and ventilated environment for use next time.

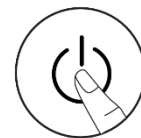
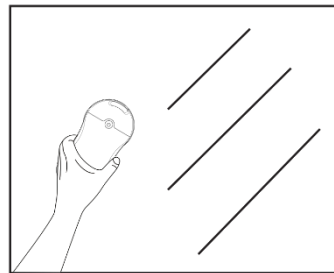

Function of Cleaning

Wipe with Dry Cleaning Pad

A. For wiping at the first time, be sure to “wipe with dry cleaning pad”. Do not spray water and remove the sand on the glass surface.

B. If spraying water (or detergent) on the cleaning pad or glass first, the water (or detergent) will mix with sand and turn into mud which cleaning effect is poor.

C. When the robot is used in sunny or low humidity weather, it is better to wipe with dry cleaning pad.

Noted: If the glass is not dirty heavily, please spray the water on the glass surface or cleaning pad before cleaning to avoid slipping.

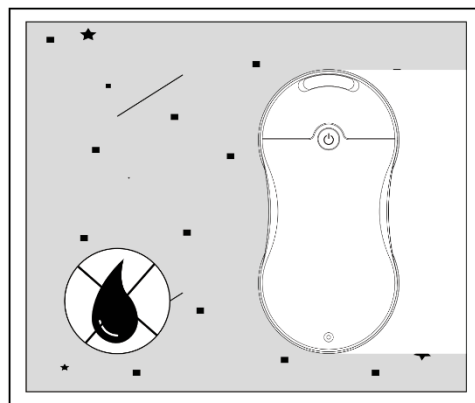

Water Spraying Function

The robot is equipped with 2 water spray nozzles. When the robot is cleaning to the left, the left water spraying nozzle will automatically spray water. When the machine is cleaning to the right, the right water spraying nozzle will automatically spray water.

1. Automatic Water Spraying

A. When the robot is cleaning, it will spray water automatically.

B. Press this button “”, the robot issues “beep” sound, and the robot turn off the automatic water spraying mode.

2. Manual Water Spraying

When the robot is cleaning, it will spray water once for each short press of button “”

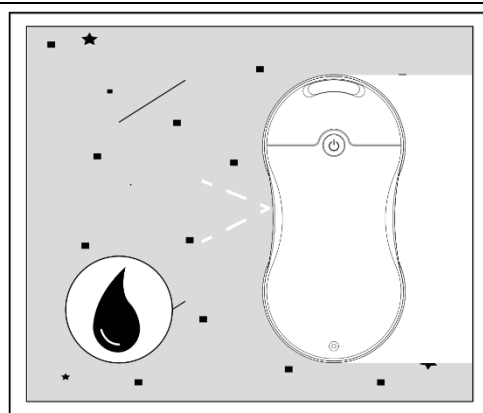

Three Intelligent Path Planning Modes

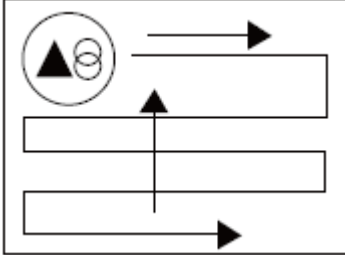
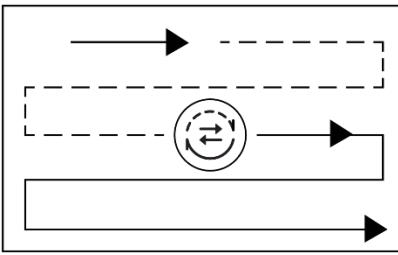
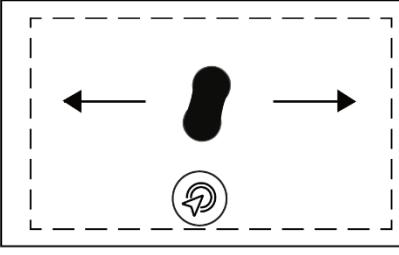
		
First towards up then towards down	Continue cleaning	Spot cleaning

UPS Power Failure System

- A.** The robot will keep adsorption about 20 minutes when power failure
- B.** When there is a power failure, the robot will not move forward. It will issue a warning sound. The red light flashes. To avoid falling down, take down the robot as soon as possible.
- C.** Use the safety rope to gently pull the robot back. When pulling the safety rope, try to be as close to the glass as possible to avoid falling down of the robot.

LED Indicator Light

Status	LED Indicator Light
During charging	Red and blue light flashes alternately
Complete charging	Blue light is on
Power failure	Red light flashing with "beep" sound
Low vacuum pressure	Red light flash one time with "beep" sound
Vacuum pressure leakage during working	Red light flash one time with "beep" sound

Note: When the red light is flashing and the robot issues "beep" warning sound, check whether or not the power adapter connects with power normally.

Maintenance

Take off the cleaning pad, soak in water (about 20°C) for 2 minutes, then gently wash by hands and dry in the air for future use. The cleaning pad should be washed by hand only in water with 20°C, machine washing will destroy the inner structure of the pad.

Good maintenance is conducive to prolonging the service life of the pad. After the product has been used for a period of time, if the pad cannot stick tightly, replace it in time to achieve the best cleaning effect.

Troubleshooting

1. When the cleaning cloth is used for the first time (especially in the dirty environment of the outer window glass), the machine may run slowly or even fail.
 - A. When unpacking the machine, clean and dry the supplied cleaning cloth before use.
 - B. Spray a little water evenly on the cleaning cloth or the surface of the glass to be wiped.
 - C. After the cleaning cloth is dampened and wrung out, put it into the cleaning ring of the machine for use.
2. The machine will test itself at the beginning of operation. If it can not run smoothly and there is a warning sound, it means that the friction is too large or too small.
 - A. Whether the cleaning cloth is too dirty.
 - B. The efficient of friction of glass stickers and fog stickers is relatively low, so they are not suitable for use.
 - C. When the glass is very clean, it will be too slippery.
 - D. When the humidity is too low (air conditioning room), the glass will be too slippery after wiping for many times.
3. The machine cannot wipe the upper left side of the glass.

You can use the remote control manual window cleaning mode to wipe the part that has not been wiped (sometimes the glass or cleaning cloth is slippery, the width of the wiped glass is larger, and the top line slides a little, resulting in the upper left position can not be wiped).
4. Possible reasons for slipping and not climbing when climbing.
 - A. The friction is too small. The friction coefficient of stickers, thermal insulation stickers or fog stickers is relatively low.
 - B. The cleaning cloth is too wet when the glass is very clean, it will be too slippery.
 - C. When the humidity is too low (air conditioning room), the glass will be too slippery after wiping for many times.
 - D. When starting the machine, please place the machine at a distance from the window frame to avoid wrong judgment.

Technical Specifications

Input voltage	AC100~240V 50Hz~60Hz
Rated power	72W
Battery capacity	500mAh
Product size	295 x 145 x 55mm
Suction	2800Pa
Net weight	1.2kg
UPS power failure protection time	20min
Control method	Remote Control
Working noise	65~70dB
Frame detection	Automatic
Anti-fall system	UPS power failure protection / Safety rope
Cleaning mode	3 types
Water spraying mode	Manual / Automatic

Support

Service phone No. for technical support: 01805 012643* (14 cent/minute from German fixed-line and 42 cent/minute from mobile networks). Free

Email: support@technaxx.de

The support hotline is available Mon-Fri from 9am to 1pm & 2pm to 5pm
In the event of anomalies and accidents, please contact:
gpsr@technaxx.de

Care and maintenance

Clean the device only with a dry or slightly damp, lint-free cloth.

Do not use abrasive cleaners to clean the device.

This device is a high-precision optical instrument, so in order to avoid damage, please avoid the following practice:

- Use the device in ultra-high or ultra-low temperature.
- Keep it or use it in moist environment for long.
- Use it in rainfalls or in water.
- Deliver or use it in strongly shocking environment.

Declaration of Conformity



Technaxx Deutschland GmbH & Co. KG hereby declares that the radio equipment type LX-083 Prod. ID.:5471 is in compliance with Directive 2014/53/EU. The full text of the EU Declaration of Conformity is available at the following internet address: www.technaxx.de/reseller

Disposal



Disposal of the packaging. Sort packaging materials by type upon disposal.

Dispose of cardboard and paperboard in the waste paper. Foils should be submitted for recyclables collection.



Disposing of old equipment (Applies in the European Union and other European countries with separate collection (collection of recyclable materials) Old equipment must not be disposed of with household waste! Every consumer is required by law to dispose of old devices that can no longer be used separately from household waste, e.g. at a collection point in his or her municipality or district. This ensures that the old devices are properly recycled and that negative effects on the environment are avoided. For this reason, electrical devices are marked with the symbol shown here.



Batteries and rechargeable batteries must not be disposed of in household waste! As a consumer, you are required by law to dispose of all batteries and rechargeable batteries, whether they contain harmful substances* or not, at a collection point in your community/city or with a retailer, to ensure that the batteries can be disposed of in an environmentally friendly manner. * marked with: Cd = cadmium, Hg = mercury, Pb = lead. Return your product to your collection point with the fully discharged battery installed inside!

Made in China

Distributed by:
Technaxx Deutschland GmbH & Co. KG
Konrad-Zuse-Ring 16-18,
61137 Schöneck, Germany

Lifenaxx Window Cleaning Robot LX-083