

MusicMan® * User Manual

Karaoke Microphone Elegance BT-X45

The manufacturer Technaxx Deutschland GmbH & Co.KG hereby declares that this device, to which this user manual belongs, complies with the essential requirements of the standards referred to the Directive **RED 2014/53/EU**. The Declaration of Conformity you find here: www.technaxx.de/ (in bar at the bottom “Konformitätserklärung”). Before using the device the first time, read the user manual carefully.

Service phone No. for technical support: 01805 012643 (14 cent/minute from German fixed-line and 42 cent/minute from mobile networks). Free Email: support@technaxx.de

This device has a rechargeable battery. It must be fully charged before first use. NOTE: Charge the battery of the device every 2–3 month if it is not used! Turn OFF nearby Bluetooth devices to avoid signal interference! WARNING: DO NOT TURN THE VOLUME TOO HIGH – HEARING LOSS MIGHT BE THE RESULT!

Keep this user manual for future reference or product sharing carefully. Do the same with the original accessories for this product. In case of warranty, please contact the dealer or the store where you bought this product. **Warranty 2 years**

Features

- Karaoke microphone with 2x 5W high quality stereo speakers
- Music streaming (MP3) via Bluetooth V4.2, MicroSD card (up to 32GB), AUX-IN (mobile phone, tablets, notebook, PC, etc.)
- EOV function (Eliminate Original Voice = suppress original voice)
- Echo function
- AUX output for connection to external HiFi systems
- Fun at singing via various singing & Karaoke APPs
- Singing with family & friends, for ceremonies & parties
- High quality housing & easy handling

Technical specifications

Bluetooth	V4.2 / Profile A2DP / ~10m distance / transmitting frequency 2.4GHz / radiated output power max. 2.5mW	
Functions	Bluetooth, MicroSD Card, AUX-IN, Earphone output	
Output	2x 5W speaker	
Input	1x microphone (MIC is inside the microphone head)	
Power	Built-in rechargeable 1000mAh Li-polymer battery type 1850 4.2V	
Charging time	~2–3 hours	
Playing time	~5–8 hours (medium volume, Bluetooth)	
Frequency range speaker	100Hz~10kHz	
Maximum sound pressure level	>115dB, 1kHz, THD<1%	
SNR / Speaker impedance	≤ 80dB / 2Ω	
MicroSD* card	up to 32GB (FAT 32) [*not included]	
Charging voltage / Current	DC 5V / 1A	
Material	Aluminium + ABS Plastic	
Weight / Dimensions	330g / (L) 24.5 x (B) 7.5 x (H) 7.5cm	
Package Contents	MusicMan® Karaoke Microphone Elegance BT-X45, USB-to-Micro USB charging cable, Micro USB-to-Audio cable (AUX) with 3,5mm jack, User Manual	



Hints for Environment Protection: Packages materials are raw materials and can be recycled. Do not disposal old devices or batteries into the domestic waste.

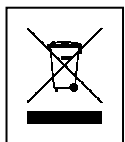





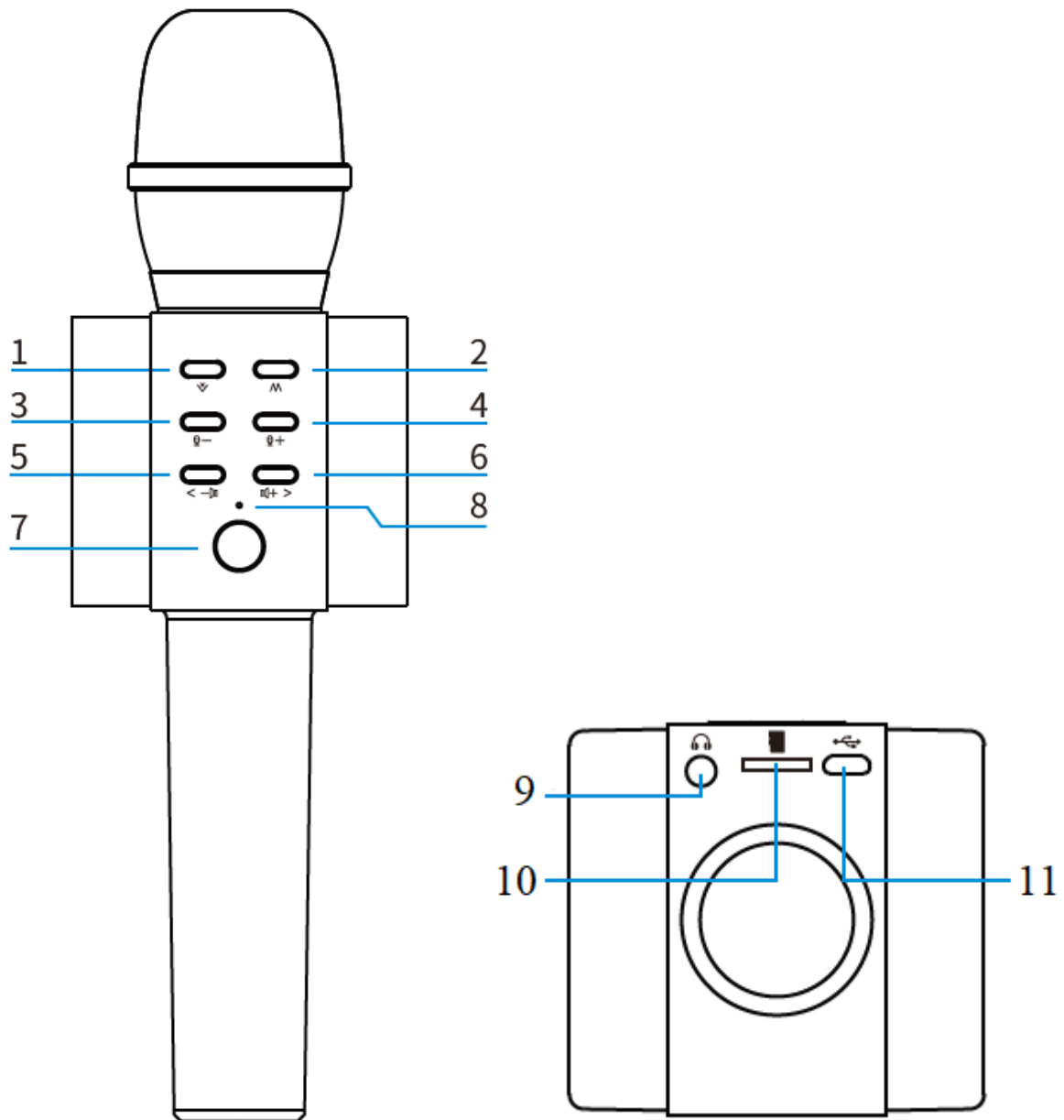

Cleaning: Protect the device from contamination and pollution (use a clean drapery). Avoid using rough, coarse-grained materials or solvents/aggressive cleaner. Wipe the cleaned device accurately. **Distributor:** Technaxx Deutschland GmbH & Co.KG, Kruppstr. 105, 60388 Frankfurt a.M., Germany

Product overview



Buttons & Functions

1	 EOV (E liminate O riginal V oice)	Press 1x to eliminate the original voice of the artist, press again to close this function.
2	 Mode	Press to choose mode Bluetooth, MicroSD card, or AUX-IN.

3	 Echo	Press to decrease echo effect. When you hear a “beep” sound minimum is reached.
4	 Echo	Press to increase echo effect. When you hear a “beep” sound maximum is reached.
5	 (see <Prev)	Short press to previous song. Long press to decrease music volume. When you hear a “beep” sound minimum is reached.
6	 (see Next>)	Short press to next song. Long press to increase music volume. When to hear a “beep” sound at its maximum.
7	Power key On/Off (Play/Pause)	Long press to power on/off. Short press to play or pause music playback.
8	Power / Charging indicator light	Light turns BLUE as it is powered on. Light turns RED when charging. RED light turns off when battery is fully charged.
9	3.5mm earphone port	Connect with a headphone or HiFi system for external playback.
10	MicroSD card Slot	Insert a MicroSD card up to 32GB with MP3 music.
11	USB charging / AUX-IN	Either for charging the device or for music input use.

We recommend selecting songs that support the EOv feature.

Charging

The BT-X45 will turn off automatically as its battery power is too low. The battery must be fully charged before first use (~2–3 hours). Plug the charging cable into MicroUSB slot of the microphone, USB slot of PC or other USB slot of chargers to get charged.

We recommend, charging the battery at least every 2–3 months, even if the BT-X45 is not used. When the microphone is being charged, indicator light turns RED.

Once it is fully charged, indicator light turns off. (We suggest to turn off the microphone while charging, otherwise charging process will take longer). It turns off automatically at low battery power.

Bluetooth mode

→ Turn on the microphone. Press and hold the Power button.

→→ When the indicator next to the Power button lights up BLUE, the microphone is in operating mode.

→→→ Connect the microphone with your Bluetooth device. (eg: smart phone, tablet, notebook, PC). Go to settings and scan for the new devices in your Smartphone. The name of the microphone "**MusicMan BT-X45**" appears, you have to select and connect it.

Note: Press "0000" on Smartphone/tablet once password wanted in Bluetooth connection.

→→→→ After successful Bluetooth pairing, you hear a conformation sound, but the complete connection between both devices takes some more seconds. Start your music playing from your device. User could start singing following the music.

→→→→→ Press the key **Power** to play/pause; press the key **<Prev** to go back to last track. Press the key **Next>** to move on to next track.

Note:

- For best sound quality hold the microphone close in front of your mouth (max. distance 2cm) and nearly in vertical position.
- When the Micro USB audio cable is used, the Bluetooth connection of the same mobile device (eg., smartphone, tablet, Notebook, PC, etc.) is automatically disconnected.

MicroSD card mode

You have the possibility to connect a MicroSD (max. 32GB) Card and playback songs from it. Format the MicroSD Card to FAT32.

Turn on the BT-X45, plug in MicroSD Card with music (MP3) into the slot of the microphone, it begins streaming music automatically. User could start singing.

Press the **POWER** key to play/pause music. Press the key **<Prev** to go back to last track. Press the key **Next>** to move on to next track.

Note: You need to access the song lyrics elsewhere (eg. print them out from the internet).

AUX mode (wired mode)

→ **use the Micro USB audio cable**

You can also connect the BT-X45 with your mobile device (eg. Smartphone, Tablet, PC, etc.) with the supplied Micro USB-to- Audio cable. Then open any karaoke APP of your choice or alternatively YouTube or playback songs from your Smartphone.

Note:

- Third party Karaoke APPs are either for free, or you are charged. Search in the Google Play Store or Apple APP Store for them (searching words: sing, karaoke, etc.). Select a song and you can start singing directly.
- The BT-X45 CANNOT do any recordings by itself.
- Depending on the loaded APP, recordings on your mobile device could be an option.
- When using the Micro USB-to-Audio cable, the Bluetooth connection of the same mobile device (eg. smartphone, tablet, notebook, PC, etc.) is automatically disconnected.

Compatible with most mobile phones and tablets

- iPhone 6 / 6 Plus / 6s / 6s Plus / 5SE / 7 / 7Plus / 8 / 8 Plus / X
- iPad mini 2 / mini 4 / new iPad / iPad air 1 / iPad air 2 / iPad Pro
- Samsung Galaxy S6 / S6 edge / S7 / S7 edge / S8 / S9
- Samsung Galaxy Note3 / Note4 / Note5 / Note edge
- HTC, BlackBerry, Sony, LG, Motorola etc.

Troubleshooting

- The microphone powers OFF or does not turn ON again
 - might be either a low battery or a problem with the power supply
 - charge the microphone and check the connection of the Micro USB cable.

- The microphone does not play the voice
 - the volume of the microphone might be too low →→ turn on or adjust the volume of the microphone (Button 4) or change the position of microphone head to mouth.

- Noises are heard from the microphone → might be a weak Bluetooth signal (to avoid noise, stay within the BT range of ~10m.)
- No Bluetooth connection → (a) might be the Bluetooth connection is not within the range →→ (a) shorten the range to the Smartphone, or (b) another mobile device (eg. Smartphone, Tablet) is paired with the microphone →→ (b) unpair the other device.

Warnings

- If the microphone does not turn on after switching it on, or it turns off after turning it on, check whether the battery is fully charged. If it is OFF power, get it fully charged and try again later. (charge the microphone all 2–3 month if it is not used for a long time.)
- Only charge the microphone through the DC 5V Micro USB port by using the provided original Micro USB charging cable. You also can use an USB charging adapter but ONLY (!) up to DC 5V/1A. Do not (!) charge the microphone with more power!
- When the microphone works under AUX-IN mode, do not (!) increase the volume of your mobile phone, PC, MP3/MP4 Player, CD/DVD etc. to a large extend. A sound distortion may occur. In that case, decrease volume either of mobile phone, PC, MP3/MP4 Player, CD/DVD or the microphone. The sound gets normal soon.
- If the microphone fails to link to your mobile device or if it fails to play music after being connected, the user shall check if your mobile device supports A2DP.
- Do not attempt to disassemble the microphone, it may result in short-circuit or even damage.
- Do not drop or shake the microphone, it may break internal circuit boards or mechanics.
- Keep the microphone in dry and ventilated environment. Avoid high humidity and high temperature. Also batteries should not be exposed to excessive heat or direct sunlight.
- This microphone is not water resistant; therefore keep it away from moisture.
- Keep the microphone away from little children.